



U.S. Department
of Transportation

**National Highway
Traffic Safety
Administration**

400 Seventh Street, S.W.
Washington, D.C. 20590

Dear Crash Data Researchers/Users:

Thank you for choosing crash data from the National Highway Traffic Safety Administration (NHTSA) for your research or other use. The information contained in this motor vehicle crash report is collected, maintained and distributed in accordance with Public Law 89-564. In accordance with this Public Law, NHTSA is required not to release any case information until completion of quality control procedures. These procedures include a review of the case material to extract all names, licenses and registration numbers, non-coded interview material, non-research related researcher comments in the margins, non-factual data, and the production number portion of the vehicle identification number (VIN).

If you requested NHTSA to query its database files in order to identify a specific crash, then that query was made using non-personal descriptors you provided for use in our search. This motor vehicle crash may have been identified from a data search and matches the general, non-personal descriptors you provided, but we cannot confirm that this is the specific crash report you requested.

If you have any questions with regard to the above procedures, please contact the Field Operations Branch, Crash Investigation Division, National Center for Statistics and Analysis at 202-366-4820. Again, please be advised that we cannot confirm that this is the case that you have specifically requested nor can we certify the information to be correct.

*** **



AUTO SAFETY HOTLINE
(800) 424-9393
Wash. D.C. Area 366-0123

PEDESTRIAN CASE SUMMARY

PSU 40 CASE NO. 637P TYPE OF ACCIDENT CAR/PEDESTRIAN CROSSING ROAD STRAIGHT

A. DESCRIPTION OF THE ACCIDENT SEQUENCE AND ACCIDENT PECULIARITIES

(Provide a summary of the accident sequence as well as any particular event of the accident that is noteworthy. Pedestrian injury mechanism and vehicle interaction is the focus, not pedestrian or driver culpability. Do not include any personal identifiers.) VEHICLE #1 TRAVELING EAST APPROACHING A STOPPED BUS AT INTERSECTION WHEN PEDESTRIAN STEPPED INTO ROAD FROM IN FRONT OF THE BUS AND INTO THE PATH OF VEHICLE #1. VEHICLE #1 STRUCK PEDESTRIAN WITH THE CENTER FRONT OF VEHICLE AND CARRYING PEDESTRIAN ONTO THE HOOD AND INTO THE WINDSHIELD. PED WAS TRANSPORTED TO MEDICAL CENTER.

B. PEDESTRIAN PROFILE

Pedestrian No.	Age	Sex	Treatment/Mortality	Most Severe Injury (TO BE COMPLETED BY ZONE CENTER)			
				Body Region	Ana. Struc.	AIS	Injury Source
01	28	1	3	Brain	hemorrhage	4	Windshield

Body Region	Type of Anatomic Structure	Abbreviated Injury Scale
Head	Whole Area	(1) Minor injury
Face	Vessels	(2) Moderate injury
Throat	Nerves	(3) Serious injury
Chest	Organs	(4) Severe injury
Abdomen/Pelvis	Skeletal	(5) Critical injury
Spine	Head-LOC	(6) Maximum (untreatable)
Upper Extremity	Skin-Burn	(7) Injured, unknown severity
Lower Extremity	Skin-Other	
External		

C. VEHICLE PROFILE

Vehicle No.	Class of Vehicle	Year/Make/Model	Most Severe Damage Based on Vehicle Inspection	
			Damage Plane	Damage Description
01	COMPACT	96 CHEVROLET/ CORSIKA	FRONT	SEVERE

DO NOT SANITIZE THIS FORM

ACCIDENT COLLISION DIAGRAM

NATIONAL ACCIDENT SAMPLING SYSTEM
CRASHWORTHINESS DATA SYSTEM

PSU No. 40

Case Number—Stratum 637P

Indicate
North

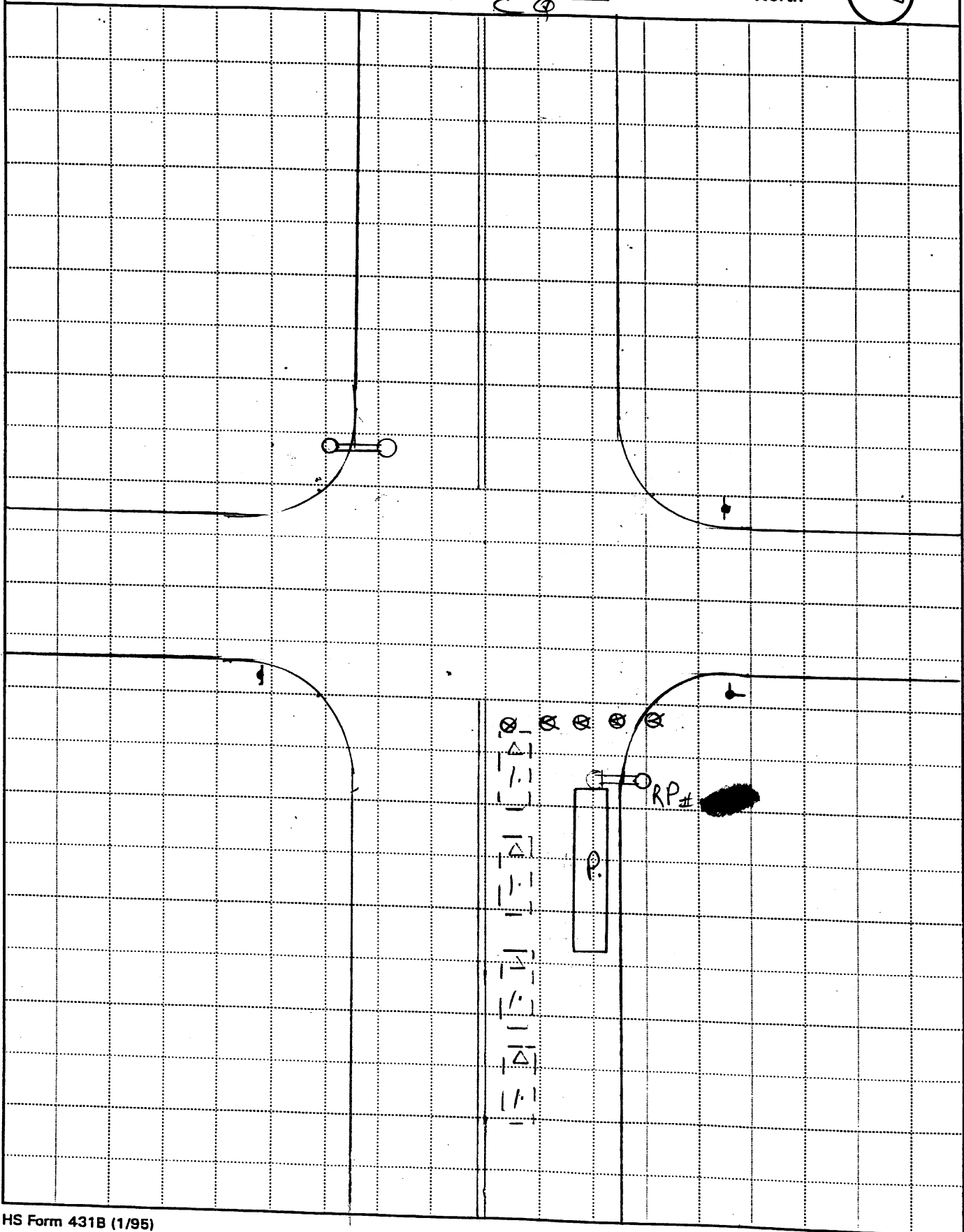
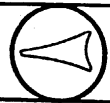

ACCIDENT COLLISION DIAGRAM

PSU No. 40

Case Number—Stratum 637P

Indicate North

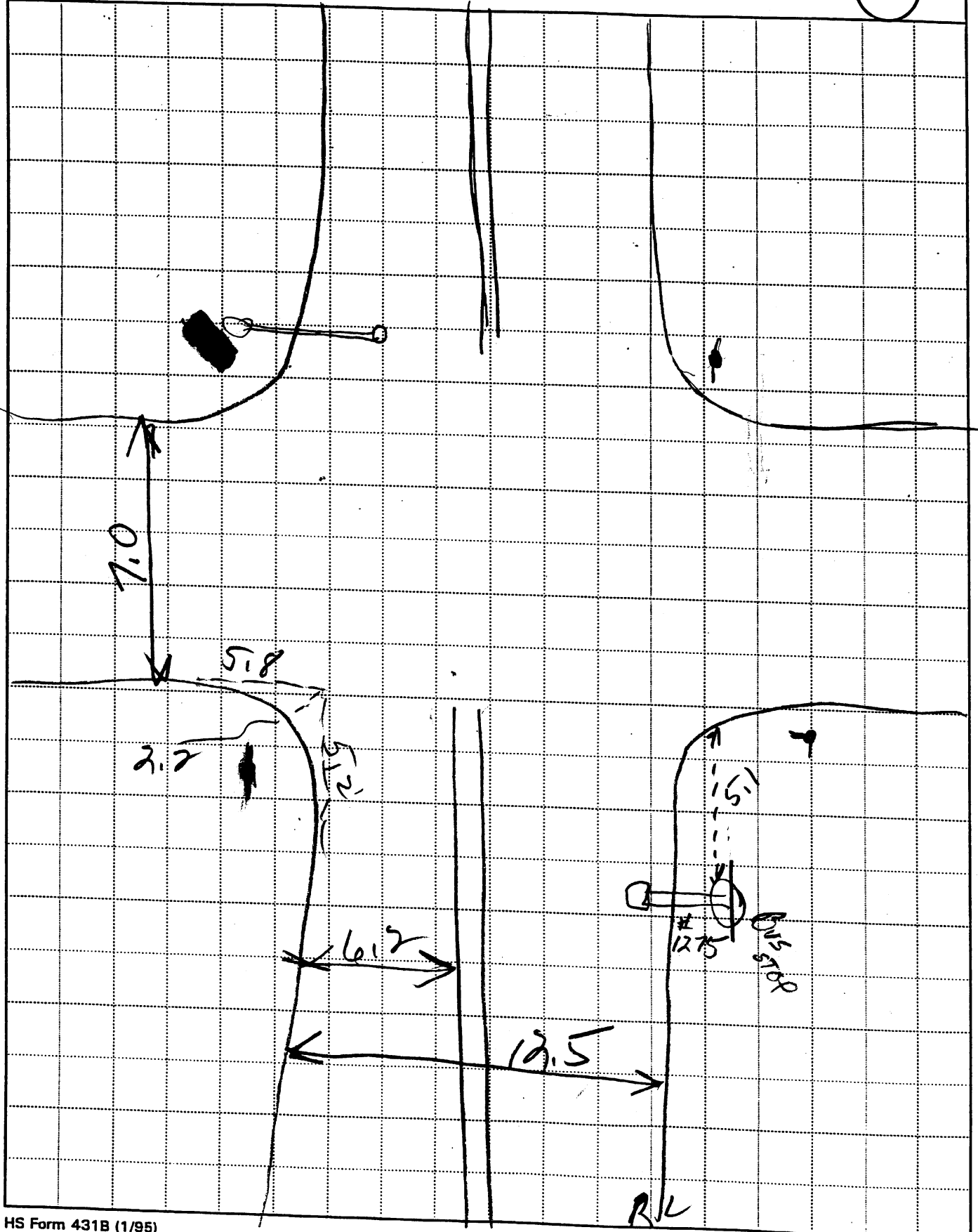
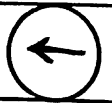

Done 1/98



PEDESTRIAN ACCIDENT COLLISION MEASUREMENT TABLE

Primary Sampling Unit Number 40

Case Number-Stratum 6 37 P
C 3

PEDESTRIAN ACCIDENT COLLISION DATA COLLECTION		SCALED DIAGRAM
* document reference point and reference line relative to physical features	Surface Type _____	* north arrow placed on diagram
* documentation of all accident induced physical evidence including (if applicable):	Surface Condition _____	* grade measurements for all applicable roadways
a) vehicle skid marks	Coefficient of Friction _____	* scaled representations of the physical plant including:
b) pedestrian contacts with ground or object	Grade (v/h) Measurement	a) all road/roadway delineation (e.g., crosswalks, curbs/edge lines, lane markings, medians, pavement markings, parked vehicles, poles, signs, etc.)
c) vehicle/pedestrian point of impact (POI)	a) at impact _____	b) all traffic controls (e.g., lights, signs)
d) location of pedestrian separation point from vehicle	b) between impact and final rest _____	* scaled representations of the vehicle and pedestrian at pre-impact, impact, and final rest based upon either:
f) final resting points (FRP) for pedestrian and vehicle	Pedestrian Travel Direction _____	a) physical evidence, or
* documentation of the physical plant including:	Vehicle Travel Direction _____	b) reconstructed accident dynamics
a) all road/roadway delineation (e.g., crosswalks, curbs/edge lines, lane markings, medians, pavement markings, parked vehicles, poles, signs, etc.)	Number of Travel Lanes _____	
b) all traffic controls (e.g., lights, signs)		

Reference Point: POLE# [REDACTED]

Reference Line: SOUTH CURBLINE

Item	Distance and Direction from Reference Point	Distance and Direction from Reference Line
R.P.	0.0	0.65
STOP SIGN SOUTHBOUND	5.0 E	17.0 N
STOP SIGN NORTHBOUND	13.1 E	5.0 S
LIGHT POLE #1280	15.7 E	13.1 N
FIRE HYDRANT	4.2 E	5.1 S

PEDESTRIAN ACCIDENT FORM

BEST AVAILABLE

NATIONAL ACCIDENT SAMPLING SYSTEM
PEDESTRIAN CRASH DATA STUDY

1. Primary Sampling Unit Number 40
 2. Case Number - Stratum 6 37 P
60

IDENTIFICATION

3. Number of General Vehicle Forms Submitted 0 1
 4. Date of Accident (Month, Day, Year) / / 97
 5. Time of Accident 1355
 Code reported military time of accident.
 NOTE: Midnight = 2400
 Unknown = 9999

SPECIAL STUDIES - INDICATORS

Check (✓) each special study (SS15-SS19 below) that has been completed; code 1 for the checked special studies and 0 for the special studies not checked.

6. SS15 Administrative Use 0
 7. ✓ SS16 Pedestrian Crash Data Study 1
 8. SS17 Impact Fires 0
 9. SS18 0
 10. SS19 0

NUMBER OF EVENTS

11. Number of Recorded Events in This Accident 0 1

PEDESTRIAN STUDY CRITERIA

Pedestrian Definition:

Any person who is on a trafficway or on a sidewalk or path contiguous with a trafficway, or on private property (e.g., parking lot). Note: Pedestrians include persons who are in contact with the ground, roadway, etc. and are pushing carts, wagons, etc. or holding on to a vehicle.

Persons in or on a nonmotorist conveyance are not pedestrians and are excluded from this study. A nonmotorist conveyance is defined as any human powered device by which a nonmotorist may move, or by which a pedestrian or nonmotorist may move another nonmotorist. A nonmotorist conveyance for purposes of this study includes the following: bicycles, baby carriages, roller skates/blades, push carts, scooters, wheelchairs, animals, etc. For example, persons on a bicycle/scooter, roller skating/blading, in a baby carriage/push cart/wheelchair or on a horse are excluded.

Case Selection Criteria:

A forward moving, late model year (VEH04 equals 90 to 95) CDS applicable vehicle (VEH07 equals 01 to 49) must strike a pedestrian.

The striking portion of the vehicle structure must be original equipment manufacturer (OEM) without previous damage and or parts removed in the impact area. For example, vehicles equipped with deer guards, winches, snow plows, etc. or previously damaged in the impact area are excluded.

The pedestrian may not be lying or sitting.

The pedestrian impact(s) are the vehicle's only impact(s). If multiple pedestrians are impacted, each pedestrian shall be a separate case.

The first point of contact between the late model year, CDS applicable vehicle and the pedestrian must be forward of the top of the A pillar.

PEDESTRIAN ACCIDENT EVENTS

Accident Event Sequence Number	Vehicle Number	Class Of Vehicle	General Area of Damage	Vehicle Number or Object Contacted	Class Of Vehicle	General Area of Damage
12. <u>0 1</u>	13. <u>0 1</u>	14. <u>0 2</u>	15. <u>F</u>	16. <u>7 2</u>	17. <u>0 0</u>	18. <u>0</u>

CODES FOR CLASS OF VEHICLE

- (00) Not a motor vehicle
- (01) Subcompact/mini (wheelbase < 254 cm)
- (02) Compact (wheelbase ≥ 254 but < 265 cm)
- (03) Intermediate (wheelbase ≥ 265 but < 278 cm)
- (04) Full size (wheelbase ≥ 278 but < 291 cm)
- (05) Largest (wheelbase ≥ 291 cm)
- (09) Unknown passenger car size
- (11) Compact utility vehicle
- (12) Large utility vehicle (≤ 4,500 kgs GVWR)
- (13) Passenger van (≤ 4,500 kgs GVWR)
- (14) Other van (≤ 4,500 kgs GVWR)
- (15) Pickup truck (≤ 4,500 kgs GVWR)
- (18) Other truck (≤ 4,500 kgs GVWR)
- (19) Unknown light truck type

CODES FOR GENERAL AREA OF DAMAGE (GAD)

CDS APPLICABLE VEHICLES

- (F) Front
- (R) Right side
- (L) Left side
- (U) Undercarriage
- (9) Unknown

CODES FOR VEHICLE NUMBER OR OBJECT CONTACTED

Collision with Nonfixed Object

- (72) Pedestrian

PEDESTRIAN ASSESSMENT FORM

1. Primary Sampling Unit Number	<u>40</u>	10. Pedestrian's Weight Code actual weight to the nearest kilogram. (999) Unknown	<u>999</u>
2. Case Number - Stratum	<u>6 37 P</u> <u>29</u>	_____ pounds X .4536 = _____ kilograms	
3. Pedestrian Number	<u>01</u>		

PEDESTRIAN'S CHARACTERISTICS

4. Pedestrian's Age 28
Code actual age at time of accident.
(00) Less than one year old (specify by month): _____
(97) 97 years and older
(99) Unknown

5. Pedestrian's Sex 1
(1) Male
(2) Female - not reported pregnant
(3) Female - pregnant-1st trimester (1st-3rd month)
(4) Female - pregnant-2nd trimester (4th-6th month)
(5) Female - pregnant-3rd trimester (7th-9th month)
(6) Female - pregnant-term unknown
(9) Unknown

6. Pedestrian's Overall Height 999
Code actual height to the nearest
centimeter.
(999) Unknown
_____ inches X 2.54 = _____ centimeters

7. Pedestrian's Height - Ground to Knee 99
Code to the nearest
centimeter.
(999) Unknown
_____ inches X 2.54 = _____ centimeters

8. Pedestrian's Height - Ground to Hip 999
Code to the nearest
centimeter.
(999) Unknown
_____ inches X 2.54 = _____ centimeters

9. Pedestrian's Height - Ground to Shoulder 999
Code to the nearest
centimeter.
(999) Unknown
_____ inches X 2.54 = _____ centimeters

PEDESTRIAN'S PRE-AVOIDANCE ACTIONS

11. Pedestrian Attitude 1
(1) Standing
(2) Crouching
(3) Kneeling
(4) Bending at waist
(8) Other (specify): _____
(9) Unknown

12. Pedestrian Motion X
(0) Not moving
(1) Walking slowly
(2) Walking rapidly
(3) Running or jogging
(4) Hopping
(5) Skipping
(6) Jumping
(7) Falling/stumbling or rising
(8) Other (specify): _____
(9) Unknown

13. Pedestrian's Action Relative to Vehicle OT
(00) Stopped
(01) Crossing road, straight
(02) Crossing road, diagonally
(03) Moving in road, with traffic
(04) Moving in road, against traffic
(05) Off road, approaching road
(06) Off road, going away from road
(07) Off road, moving parallel
(08) Off road, crossing driveway
(09) Off road, moving along driveway
(98) Other (specify): _____
(99) Unknown

14. Pedestrian's Body (Chest) Orientation 9
Relative to Striking Vehicle Prior to
Avoidance Actions
(1) Facing vehicle
(2) Facing away
(3) Left side to vehicle
(4) Right side to vehicle
(8) Other (specify): _____
(9) Unknown

PEDESTRIAN'S AVOIDANCE ACTIONS15. Pedestrian's First Avoidance Actions 99

- (00) No avoidance actions
- (01) Stopped
- (02) Accelerated pace
- (03) Ran away (along vehicle path)
- (04) Jumped
- (05) Turned toward vehicle
- (06) Turned away from vehicle
- (07) Dove or fell away

Used hand(s) to :

- (11) Vault corner of vehicle
- (12) Vault onto vehicle
- (13) Brace against vehicle
- (14) Crouched and braced hands against vehicle
- (98) Other (specify): _____
- (99) Unknown

PEDESTRIAN'S ORIENTATION AT IMPACT16. Pedestrian's Head Orientation at Initial Impact 9

- (1) To front
- (2) To left
- (3) To right
- (4) Up
- (5) Down
- (8) Other (specify): _____
- (9) Unknown

17. Pedestrian's Body (Chest) Orientation at Initial Impact 9

- (1) Facing vehicle
- (2) Facing away
- (3) Left side to vehicle
- (4) Right side to vehicle
- (8) Other (specify): _____
- (9) Unknown

18. Pedestrian's Arm Orientation at Initial Impact 99

- (01) At sides
- (02) Folded across chest
- (03) Hands clasped behind back
- (04) Hands on hips
- (05) Hands in pockets

One or both arms:

- (06) Extended upward
- (07) Extended to side
- (08) Extended forward bracing
- (09) Extended, holding object (briefcase, suitcase, etc.)
- (10) Holding object (young child, grocery bag, etc.) in arm(s)
- (11) Holding object (young child, grocery bag, etc.) on shoulder(s) or head
- (98) Other (specify): _____
- (99) Unknown

19. Pedestrian's Leg Orientation at Initial Impact 99

- (01) Together
- (02) Apart-laterally
- (03) Apart-right leg forward
- (04) Apart-left leg forward
- (05) Apart- forward leg unknown
- (06) Left foot off the ground
- (07) Right foot off the ground
- (08) Both feet off the ground
- (98) Other (specify): _____
- (99) Unknown

20. Vehicle/Pedestrian's Interaction 02

- (01) Carried by vehicle, wrapped position
- (02) Carried by vehicle, slid to windshield
- (03) Carried by vehicle, position unknown
- (04) Passed over vehicle top
- (05) Thrown straight forward
- (06) Thrown forward and left of vehicle
- (07) Thrown forward and right of vehicle
- (08) Knocked to pavement, forward
- (09) Knocked to pavement, left of vehicle
- (10) Knocked to pavement, right of vehicle
- (11) Knocked to pavement, run over or dragged by vehicle
- (12) Shunted to left (corner impacts only)
- (13) Shunted to right (corner impacts only)
- (14) Bumped or pushed aside
- (15) Snagged, rotated
- (16) Snagged, dragged by vehicle
- (17) Foot or legs run over
- (98) Other (specify): _____
- (99) Unknown

OFFICIAL RECORDS

INJURY CONSEQUENCES

21. Police Reported Alcohol Presence
For Pedestrian

- (0) No alcohol present
(1) Yes alcohol present
(7) Not reported
(9) Unknown

1

22. Alcohol Test Result For Pedestrian
Code actual value (decimal implied
before first digit—0.xx)

- (95) Test refused
(96) None given
(97) AC (Alcohol Content)
test performed, results unknown
(99) Unknown if test given

96

Source: _____

23. Police Reported Other Drug Presence
For Pedestrian

- (0) No other drug(s) present
(1) Yes other drug(s) present
(7) Not reported
(9) Unknown

0

24. Other Drug Specimen Test Result
For Pedestrian

- (0) No specimen test given
(1) Drug not found in specimen
(2) Drug found in specimen,
(specify): _____
(3) Specimen test given,
results unknown or not obtained
(9) Unknown

0

25. Injury Severity (Police Rating)

- (0) O - No injury
(1) C - Possible injury
(2) B - Nonincapacitating injury
(3) A - Incapacitating injury
(4) K - Killed
(5) U - Injury, severity unknown
(6) Died prior to accident
(9) Unknown

3

26. Treatment - Mortality

- (0) No treatment
(1) Fatal
(2) Fatal - ruled disease (specify):

3

Nonfatal

- (3) Hospitalization
(4) Transported and released
(5) Treatment at scene - non-transported
(6) Treatment later
(8) Treatment - other (specify):

(9) Unknown

27. Type Of Medical Facility
(for Initial Treatment)

- (0) Not treated at a medical facility
(1) Trauma center
(2) Hospital
(3) Medical clinic
(4) Physician's office
(5) Treatment later at medical facility
(8) Other (specify): _____
(9) Unknown

1

28. Hospital Stay

- (00) Not Hospitalized
_____ Code the number of days (up through 60)
that the pedestrian stayed in a hospital.
(61) 61 days or more
(99) Unknown

99

29. Working Days Lost

- _____ Code the number of days
(up through 60) that the pedestrian
lost from work due to the accident
(00) No working days lost
(61) 61 days or more
(62) Fatally injured
(97) Not working prior to accident
(99) Unknown

99

STOP - VARIABLES 30 THROUGH 37 ARE COMPLETED BY THE ZONE CENTER

30. Glasgow Coma Scale (GCS) Score 1 2
 (at Medical Facility)
 (00) Not injured
 (01) Injured - not treated at medical facility
 (02) No GCS Score at medical facility
 (03-15) Code the actual value of the initial GCS Score recorded at medical facility.
 (97) Injured, details unknown
 (99) Unknown if injured

31. Was the Pedestrian Given Blood? 9
 (1) No - blood not given
 (2) Yes - blood given
 (specify units): _____
 (9) Unknown if blood given

32. Arterial Blood Gases (ABG) - HCO₃ 0 1
 (00) Not injured
 (01) Injured, ABGs not measured or reported
 (02-50) Code the actual value of the HCO₃
 (96) ABGs reported, HCO₃ unknown
 (97) Injured, details unknown
 (99) Unknown if injured

33. Time to Death 0 0
 _____ Code number of hours from time of accident to time of death up through 24 hours. If time of death is greater than 24 hours, code number of days. (Note: 1 day = 31, 2 days = 32, ... n days = 30 + n up through 30 days = 60)
 (00) Not fatal
 (96) Fatal - ruled disease
 (99) Unknown

34. 1st Medically Reported Cause of Death 0 0

35. 2nd Medically Reported Cause of Death 0 0

36. 3rd Medically Reported Cause of Death 0 0
 _____ Code the Pedestrian Injury from line number(s) for the medically reported injury(s) which reportedly contributed to this pedestrian's death
 (00) Not fatal or no additional causes
 (96) Mode of death given but specific injuries are not linked to cause of death. (specify): _____
 (97) Other result (includes fatal ruled disease) (specify): _____
 (99) Unknown

37. Number of Recorded Injuries for This Pedestrian 0 9
 _____ Code the actual number of injuries recorded for this pedestrian.
 (00) No recorded injuries
 (97) Injured, details unknown
 (99) Unknown if injured

ARE ALL APPLICABLE MEDICAL RECORDS INCLUDED WITH INITIAL SUBMISSION?
 NO [] YES [✓]

UPDATE CANDIDATE? NO [✓] YES []

PEDESTRIAN INJURY FORM

1. Primary Sampling Unit Number	<u>40</u>	3. Pedestrian Number	<u>0 1</u>
2. Case Number - Stratum	<u>6 37 P</u> <u>CG</u>	4. Blank	<u>X X</u>

INJURY DATA

Record below the actual injuries sustained by this pedestrian in CHRONOLOGICAL order that were identified from the official and unofficial data sources. Remember not to double count an injury just because it was identified from two different sources. If greater than twenty-five injuries have been documented, encode the balance on the Pedestrian Injury Supplement.

Source of Injury Data	AIS-90							Injury Source	Injury Source Confidence Level	Direct/ Indirect Injury	Striking Profile	Type Of Damage	Damage Depth
	Body Region	Type of Anatomic Structure	Specific Anatomic Structure	Level of Injury	A.I.S. Severity	Aspect	Injury Source						
<i>bilateral Cerebrum Contusions</i>	5th <u>2</u>	6th <u>1</u>	7th <u>4</u>	8th <u>06</u>	9th <u>22</u>	10th <u>3</u>	11th <u>3</u>	12th <u>775</u>	13th <u>1</u>	14th <u>1</u>	15th <u>2</u>	16th <u>5</u>	17th <u>5</u>
<i>Rib fx w/ pneumothorax</i>	18th <u>3</u>	19th <u>4</u>	20th <u>5</u>	21st <u>02</u>	22nd <u>22</u>	23rd <u>3</u>	24th <u>1</u>	25th <u>770</u>	26th <u>1</u>	27th <u>1</u>	28th <u>2</u>	29th <u>3</u>	30th <u>3</u>
<i>Fibula fx</i>	31st <u>2</u>	32nd <u>8</u>	33rd <u>5</u>	34th <u>16</u>	35th <u>06</u>	36th <u>2</u>	37th <u>2</u>	38th <u>702</u>	39th <u>1</u>	40th <u>1</u>	41st <u>2</u>	42nd <u>2</u>	43rd <u>2</u>
<i>Tibia fx</i>	44th <u>2</u>	45th <u>8</u>	46th <u>5</u>	47th <u>34</u>	48th <u>22</u>	49th <u>3</u>	50th <u>2</u>	51st <u>706</u>	52nd <u>1</u>	53rd <u>1</u>	54th <u>2</u>	55th <u>2</u>	56th <u>2</u>
<i>La occipital lac.</i>	57th <u>3</u>	58th <u>1</u>	59th <u>9</u>	60th <u>06</u>	61st <u>02</u>	62nd <u>1</u>	63rd <u>6</u>	64th <u>775</u>	65th <u>1</u>	66th <u>1</u>	67th <u>2</u>	68th <u>5</u>	69th <u>5</u>
<i>CHI</i>	70th <u>3</u>	71st <u>1</u>	72nd <u>6</u>	73rd <u>06</u>	74th <u>99</u>	75th <u>2</u>	76th <u>0</u>	77th <u>775</u>	78th <u>1</u>	79th <u>1</u>	80th <u>2</u>	81st <u>5</u>	82nd <u>5</u>
<i>Multi abrasions head</i>	83rd <u>3</u>	84th <u>1</u>	85th <u>9</u>	86th <u>02</u>	87th <u>02</u>	88th <u>1</u>	89th <u>9</u>	90th <u>775</u>	91st <u>1</u>	92nd <u>1</u>	93rd <u>2</u>	94th <u>5</u>	95th <u>5</u>
<i>Right intracerebral hemorrhages</i>	96th <u>2</u>	97th <u>1</u>	98th <u>4</u>	99th <u>06</u>	100th <u>40</u>	101st <u>4</u>	102nd <u>1</u>	103rd <u>775</u>	104th <u>1</u>	105th <u>1</u>	106th <u>2</u>	107th <u>5</u>	108th <u>5</u>
<i>Multiple Contusions</i>	109th <u>3</u>	110th <u>9</u>	111th <u>9</u>	112th <u>04</u>	113th <u>00</u>	114th <u>1</u>	115th <u>0</u>	116th <u>775</u>	117th <u>1</u>	118th <u>1</u>	119th <u>2</u>	120th <u>5</u>	121st <u>5</u>
	122th	123th	124th	125th	126th	127th	128th	129th	130th	131th	132th	133th	134th

OFFICIAL INJURY DATA — SOFT TISSUE INJURIES

Indicate the Location, Specific Anatomic Structure, Detail (size, depth, fracture type, head injury clinical signs and neurological deficits), and Source of all injuries indicated by official sources (or from PAR or other unofficial sources if medical records and interviewee data are unavailable.)

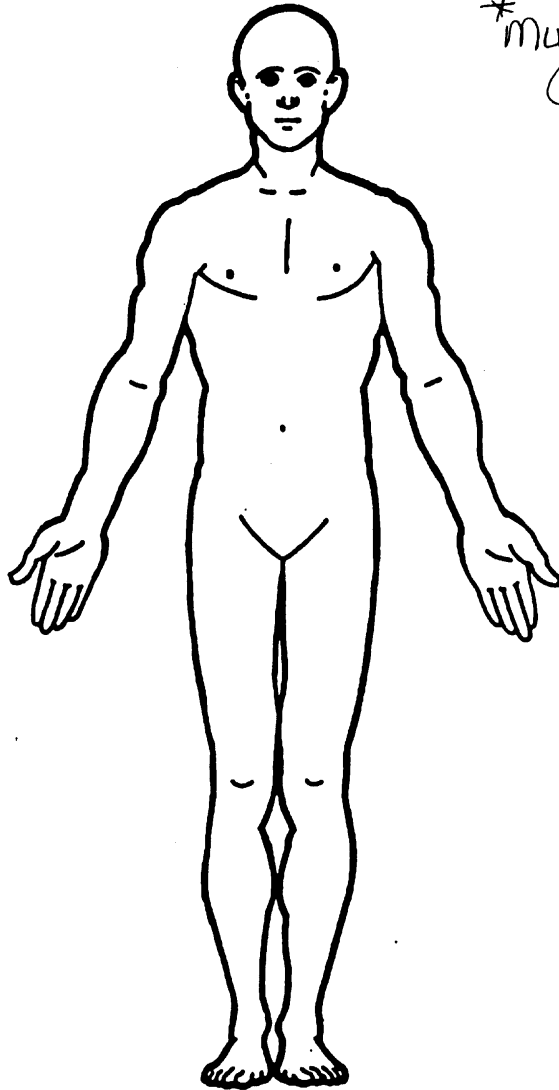

* Multiple
Contusions
(ER)

Multiple
Abrasions
on Head
(ER)

Left and Right
occipital
lacerations
(left 5cm
right 5cm)
(ER)

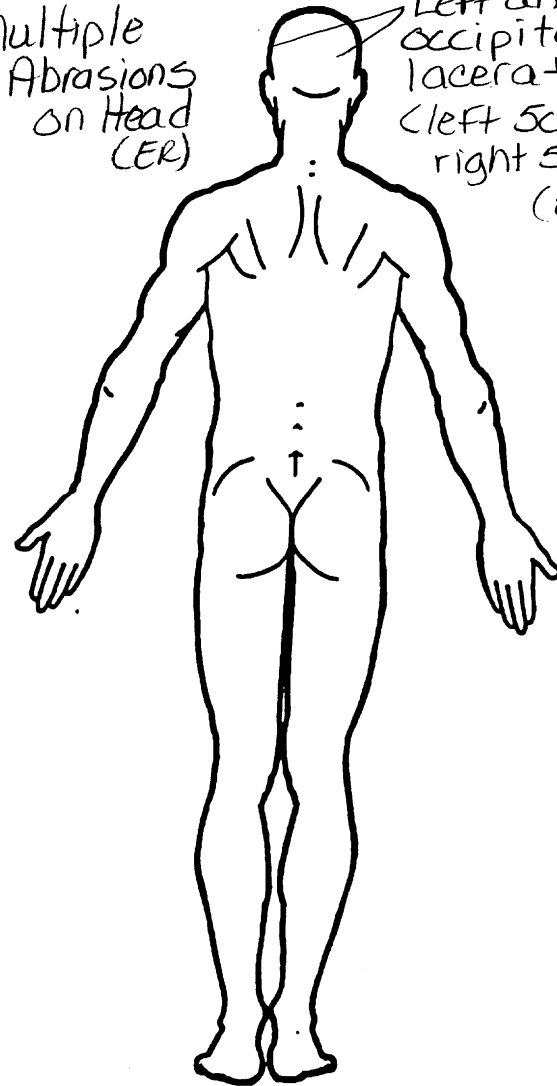

SOURCE OF INJURY DATA**OFFICIAL**

- (1) Autopsy records with or without hospital/medical records
- (2) Hospital/medical records other than emergency room (e.g., discharge summary)
- (3) Emergency room records only (including associated X-rays or other lab reports)
- (4) Private physician, walk-in or emergency clinic

UNOFFICIAL

- (5) Lay coroner report
- (6) E.M.S. personnel
- (7) Interviewee
- (8) Other source (specify): _____
- (9) Police

INJURY SOURCE CONFIDENCE LEVEL

- (1) Certain
- (2) Probable
- (3) Possible
- (9) Unknown

DIRECT/INDIRECT INJURY

- (1) Direct contact injury
- (2) Indirect contact injury
- (3) Noncontact injury
- (7) Injured, unknown source

STRIKING PROFILE

- (0) Injury not from vehicle contact
- (1) Flat-Narrow (< 15 centimeters)
- (2) Flat-Wide (≥ 15 centimeters)
- (3) Rounded (contoured)
- (4) Rounded edge
- (5) Sharp edge
- (8) Other (specify): _____
- (9) Unknown

TYPE OF DAMAGE

- BEST AVAILABLE
- (0) Injury not from vehicle contact
 - (1) No damage/contact
 - (2) Scratch (Scuff, Cloth Transfer, Smear)
 - (3) Dent
 - (4) Large deformation
 - (5) Cracked, fractured, shattered
 - (6) Separated from vehicle
 - (7) Noncontact injury
 - (8) Other specify: _____
 - (9) Unknown

DAMAGE DEPTH

- (0) Injury not from vehicle contact
- (1) No residual damage
- (2) Surface only damage
- (3) Crush depth > 0 to 2 centimeters
- (4) Crush depth > 2 to 5 centimeters
- (5) Crush depth > 5 to 10 centimeters
- (8) Other specify: _____
- (9) Unknown

PEDESTRIAN INJURY CLASSIFICATION**Body Region**

- (1) Head
- (2) Face
- (3) Neck
- (4) Thorax
- (5) Abdomen
- (6) Spine
- (7) Upper Extremity
- (8) Lower Extremity
- (9) Unspecified

Specific Anatomic Structure

- Whole Area
- (02) Skin - Abrasion
 - (04) Skin - Contusion
 - (06) Skin - Laceration
 - (08) Skin - Avulsion
 - (10) Amputation
 - (20) Burn
 - (30) Crush
 - (40) Degloving
 - (50) Injury - NFS
 - (90) Trauma, other than mechanical

Spine

- (02) Cervical
- (04) Thoracic
- (06) Lumbar

Abbreviated Injury Scale

- (1) Minor injury
- (2) Moderate injury
- (3) Serious injury
- (4) Severe injury
- (5) Critical injury
- (6) Maximum (untreatable)
- (7) Injured, unknown severity

Type of Anatomic Structure

- (1) Whole Area
- (2) Vessels
- (3) Nerves
- (4) Organs (includes muscles/ligaments)
- (5) Skeletal (includes joints)
- (6) Head - LOC
- (9) Skin

Head - LOC

- (02) Length of LOC
- (04, 06, 08) Level of Consciousness
- (10) Concussion

Level of Injury

Specific injuries are assigned consecutive two-digit numbers beginning with 02.

To the extent possible, within the organizational framework of the AIS, 00 is assigned to an injury NFS as to severity or where only one injury is given in the dictionary for that anatomic structure. 99 is assigned to any injury NFS as to lesion or severity.

Aspect

- (1) Right
- (2) Left
- (3) Bilateral
- (4) Central
- (5) Anterior
- (6) Posterior
- (7) Superior
- (8) Inferior
- (9) Unknown
- (0) Whole region

INJURY SOURCEFRONT

- 700 Front bumper
- 701 Front lower valance/spoiler
- 702 Front grille
- 703 Hood edge and/or trim
- 704 Hood ornament (fixed)
- 705 Hood ornament (spring loaded)
- 706 Headlight
- 707 Retractable headlight door (Open/Closed)
- 708 Turn signal/parking lights
- 718 Other front or add on object (specify): _____
- 719 Unknown front object

Left Side Components

- 720 Front fender side surface
- 721 Front antenna
- 722 A1 pillar
- 723 A2 pillar
- 724 B pillar
- 725 C pillar
- 726 D pillar
- 728 Other pillar (specify): _____
- 729 Left side roof rail
- 730 Left side door surface
- 731 Left side door handle
- 732 Left side mirror fixed housing
- 733 Left side folding mirror
- 734 Left side glazing forward of B pillar
- 735 Left side glazing rearward of B pillar
- 736 Left side back fender or quarter panel
- 737 Rear antenna
- 738 Other left side object (specify): _____
- 739 Unknown left side component

Right Side Components

- 740 Front fender side surface
- 741 Front antenna
- 742 A1 pillar
- 743 A2 pillar

- 744 B pillar
- 745 C pillar
- 746 D pillar
- 748 Other pillar (specify): _____
- 749 Right side roof rail
- 750 Right side door surface
- 751 Right side door handle
- 752 Right side mirror fixed housing
- 753 Right side folding mirror
- 754 Right side glazing forward of B pillar
- 755 Right side glazing rearward of B pillar
- 756 Rear antenna
- 757 Rear fender or quarter panel
- 758 Other right side object (specify): _____
- 759 Unknown right side component

Back Components

- 760 Rear (back) bumper
- 761 Tailgate
- 762 Hatchback, vertical surface
- 768 Other back component (specify): _____
- 769 Unknown back component

Top Components

- 770 Hood surface
- 771 Hood surface reinforced by under hood component
- 772 Front fender top surface
- 773 Cowl area
- 774 Wiper blade & mountings
- 775 Windshield glazing
- 776 Front header
- 777 Roof surface
- 778 Backlight glazing
- 779 Rear header
- 780 Hatchback
- 781 Rear trunk lid
- 788 Other top component (specify): _____
- 789 Unknown top component

Wheels / tires

- 790 Left front wheel / tire
- 791 Right front wheel / tire
- 792 Left rear wheel / tire
- 793 Right rear wheel / tire
- 798 Other wheel / tire (specify): _____
- 799 Unknown wheel / tire

Undercarriage components

- 800 Front crossmember
- 801 Steering assembly/Front suspension
- 802 Oil pan
- 803 Exhaust system pipe
- 804 Transmission
- 805 Drive shaft
- 806 Catalytic converter
- 807 Muffler
- 808 Floor pan
- 809 Fuel tank
- 810 Rear suspension
- 818 Other undercarriage component (specify): _____
- 819 Unknown undercarriage component

Accessories

- 820 Air scoop, deflector
- 821 Cellular or CB radio antenna
- 822 Emergency lights or bar
- 823 Fog lights
- 824 Luggage, ski, or bike rack
- 825 Cargo (specify): _____
- 826 Spare tire
- 827 Spotlight
- 828 Other accessory (specify): _____

Other Object or Vehicle in Environment

- 947 Ground
- 948 Other object (specify): _____
- 949 Unknown object in environment
- 959 Unknown object on contacting vehicle
- 997 Noncontact injury source
- 999 Unknown injury source

OFFICIAL INJURY DATA — SKELETAL INJURIES

Restrained?

- No
 Yes

Indicate the Location, Specific Anatomic Structure, Detail (size, depth, fracture type, head injury clinical signs and neurological deficits), and Source of all injuries indicated by official sources (or from PAR or other unofficial sources if medical records and interviewee data are unavailable.)

Blood Alcohol Level (mg/dl)

BAL = _____

Glasgow Coma Scale Score

GCSS = _____

Units of Blood Given

Units = _____

Arterial Blood Gases

Ph = _____

PO₂ = _____

PCO₂ = _____

HCO₃ = _____

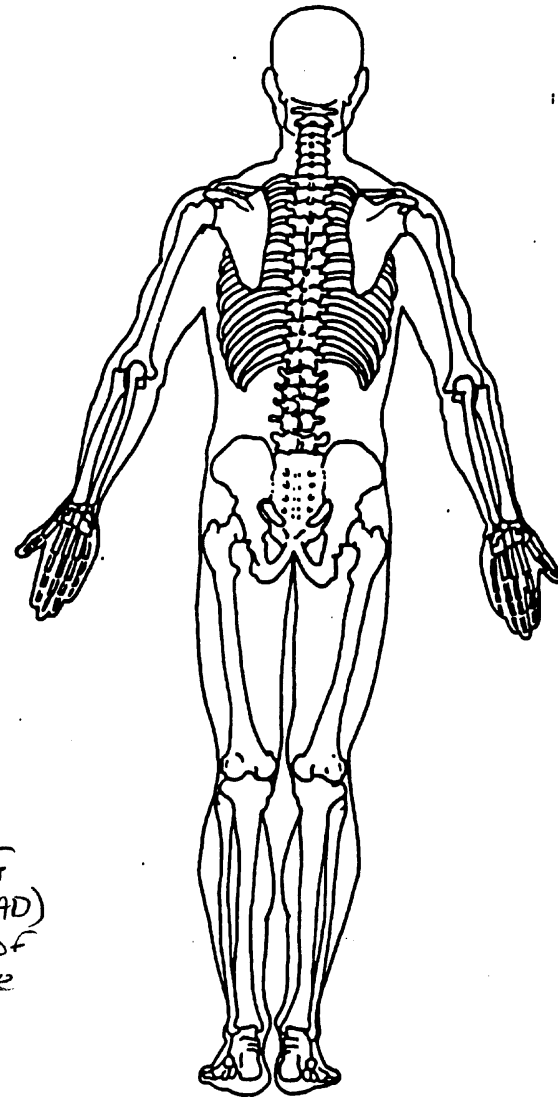
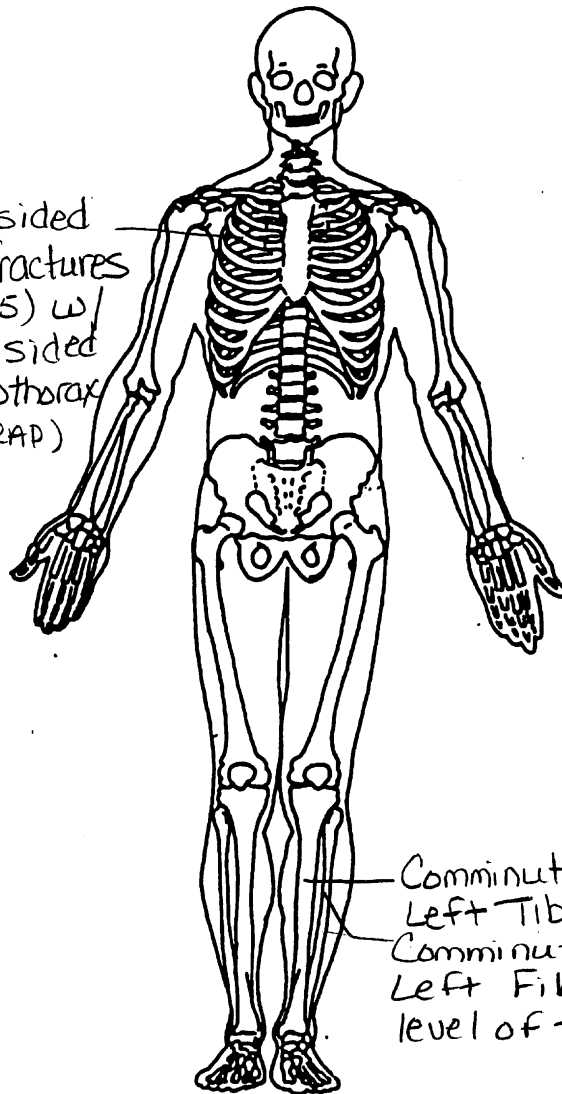

OFFICIAL INJURY DATA — INTERNAL INJURIES

Indicate the Location, Specific Anatomic Structure, Detail (size, depth, fracture type, head injury clinical signs and neurological deficits), and Source of all injuries indicated by official sources (or from PAR or other unofficial sources if medical records and interviewee data are unavailable.)

Right frontal and
parietal lobe small
intra parenchymal
hematoma = intracerebral
hemorrhage (RAD)

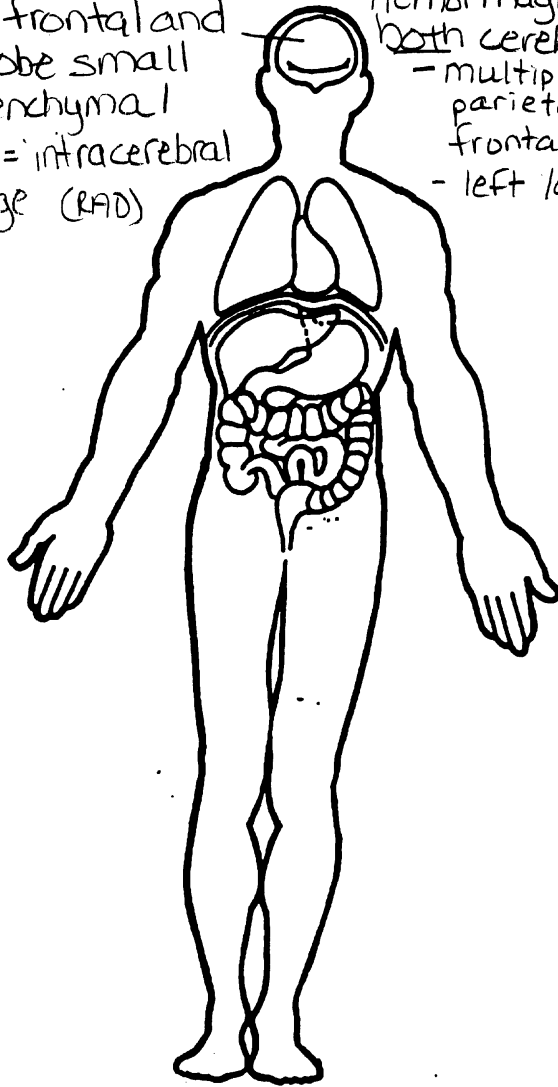

Hemorrhagic contusion of
both cerebral hemispheres.
- multiple contusions on right
parietal and single on right
frontal cortex
- left lateral contusion (small)
(RAD)

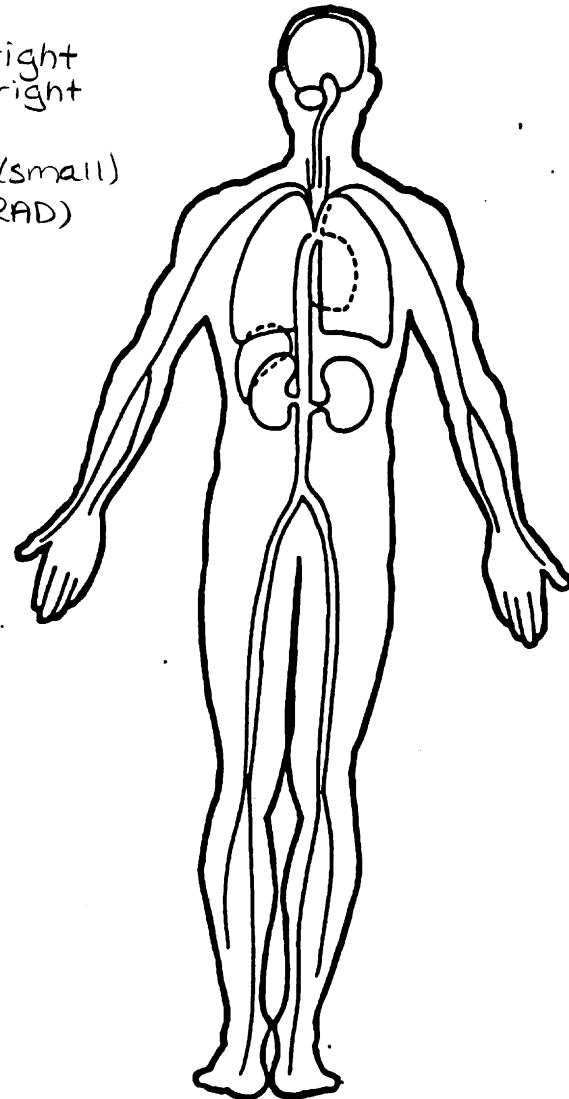



1. Primary Sampling Unit Number 40
 2. Case Number - Stratum 6 37 P
 3. Vehicle Number 0 1

OFFICIAL RECORDS

VEHICLE IDENTIFICATION

4. Vehicle Model Year 96
 Code the last two digits of the model year
 (99) Unknown

5. Vehicle Make (specify): 20
CHEVROLET
 Applicable codes are found in your
 NASS PCDS Data Collection, Coding and
 Editing Manual.
 (99) Unknown

6. Vehicle Model (specify): 0 1 9
CORSICA
 Applicable codes are found in your
 NASS PCDS Data Collection, Coding and
 Editing Manual.
 (999) Unknown

7. Body Type 04
 Note: Applicable codes may be found on
 the back of this page.

8. Vehicle Identification Number
1 2 3 4 5 6 7 8 9 10 11 12 13 14 15 16 17
1 G 1 L D 5 5 M 0 T Y [REDACTED]

Left justify; Slash zeros and letter Z (0 and Z)
 No VIN—Code all zeros
 Unknown—Code all nines

9. Police Reported Travel Speed 999
 Code to the nearest kmph (NOTE: 000 means
 less than 0.5 kmph)
 (160) 159.5 kmph and above
 (999) Unknown

___ mph X 1.6093 = ___ kmph

10. Speed Limit 048
 (000) No statutory limit
 Code posted or statutory speed limit
 in kmph
 (999) Unknown

30 mph X 1.6093 = 48 kmph

11. Police Reported Alcohol Presence For Driver 1
 (0) No alcohol present
 (1) Yes alcohol present
 (7) Not reported
 (8) No driver present
 (9) Unknown

12. Alcohol Test Result For Driver 99
 Code actual value (decimal implied
 before first digit—0.xx)
 (95) Test refused
 (96) None given
 (97) AC (Alcohol Content) test
 performed, results unknown
 (98) No driver present
 (99) Unknown

Source: _____

13. Police Reported Other Drug Presence
 For Driver 1
 (0) No other drug(s) present
 (1) Yes other drug(s) present
 (7) Not reported
 (8) No driver present
 (9) Unknown

14. Other Drug Specimen Test Result
 For Driver 9
 (0) No specimen test given
 (1) Drug not found in specimen
 (2) Drug found in specimen
 (specify): _____
 (3) Specimen test given, results
 unknown or not obtained
 (8) No driver present
 (9) Unknown

CODES FOR BODY TYPE

CDS APPLICABLE VEHICLES

Automobiles

- (01) Convertible (excludes sun-roof, t-bar)
- (02) 2-door sedan, hardtop, coupe
- (03) 3-door/2-door hatchback
- (04) 4-door sedan, hardtop
- (05) 5-door/4-door hatchback
- (06) Station wagon (excluding van and truck based)
- (07) Hatchback, number of doors unknown
- (08) Other automobile type (specify):

- (09) Unknown automobile type

Automobile Derivatives

- (10) Auto based pickup (includes El Camino, Caballero, Ranchero, Brat, and Rabbit pickup)
- (11) Auto based panel (cargo station wagon, auto based ambulance/hearse)
- (12) Large limousine - more than four side doors or stretched chassis
- (13) Three-wheel automobile or automobile derivative

Utility Vehicles (≤ 4,500 kgs GVWR)

- (14) Compact utility (Jeep CJ-2 - CJ-7, Scrambler, Golden Eagle, Renegade, Laredo, Wrangler, Cherokee [84 and after], Dispatcher, Raider, Bronco II, Bronco [76 and before], Explorer, S-10 Blazer, Geo Tracker, Bravada, S-15 Jimmy, Thing, Pathfinder, Trooper, Trooper II, Rodeo, Amigo, Navajo, 4-Runner, Montero, Samurai, Sidekick, Rocky)
- (15) Large utility (includes Jeep Cherokee [83 and before], Ramcharger, Trailduster, Bronco-fullsize [78 and after], fullsize Blazer, fullsize Jimmy, Landcruiser, Rover, Scout)
- (16) Utility station wagon (Chevy Suburban, GMC Suburban, Travelall, Grand Wagoneer, includes suburban limousine)
- (19) Utility, unknown body type

Van Based Light Trucks (≤ 4,500 kgs GVWR)

- (20) Minivan (Chrysler Town and Country, Caravan, Grand Caravan, Voyager, Grand Voyager, Mini-Ram, Dodge/Plymouth Vista, Aerostar, Villager, Lumina APV, Trans Sport, Silhouette, Astro, Safari, Toyota Van, Toyota Minivan, Previa, Nissan Minivan, Quest, Mitsubishi Minivan, Vanagon/Camper.)
- (21) Large van (B150-B350, Sportsman, Royal, Maxiwagon, Ram, Tradesman, Voyager [83 and before], E150-E350, Econoline, Clubwagon, Chateau, G10-G30, Chevy Van, Beauville, Sport Van, G15-G35, Rally Van, Vandura.)
- (22) Step van or walk-in van (≤ 4,500 kgs GVWR)
- (23) Van based motorhome (≤ 4,500 kgs GVWR)
- (24) Van based school bus (≤ 4,500 kgs GVWR)
- (25) Van based other bus (≤ 4,500 kgs GVWR)
- (28) Other van type (Hi-Cube Van, Kary) (specify):

- (29) Unknown van type

Light Conventional Trucks (Pickup style cab, ≤ 4,500 kgs GVWR)

- (30) Compact pickup (D50, Colt P/U, Ram 50, Dakota, Arrow Pickup [foreign], Ranger, Courier, S-10, T-10, LUV, S-15, T-15, Sonoma, Datsun/Nissan Pickup, P'up, Mazda Pickup, Toyota Pickup, Mitsubishi Pickup)
- (31) Large Pickup (Jeep Pickup, Comanche, Ram Pickup, D100-D350, W100-W350, F100-F350, C10-C35, K10-K35, R10-R35, V10-V35, Silverado, Sierra, R100-R500,)

- (32) Pickup with slide-in camper
- (33) Convertible pickup
- (39) Unknown pickup style light conventional truck type

Other Light Trucks (≤ 4,500 kgs GVWR)

- (40) Cab chassis based (includes rescue vehicles, light stake, dump, and tow truck)
- (41) Truck based panel
- (42) Light truck based motorhome (chassis mounted)
- (45) Other light conventional truck type
- (48) Unknown light truck type
- (49) Unknown light vehicle type (automobile, utility, van, or light truck)

OTHER VEHICLES

Buses (Excludes Van Based)

- (50) School bus (designed to carry students, not cross country or transit)
- (58) Other bus type (e.g., transit, intercity, bus based motorhome) (specify):

- (59) Unknown bus type

Medium/Heavy Trucks (> 4,500 kgs GVWR)

- (60) Step van (> 4,500 kgs GVWR)
- (61) Single unit straight truck (4,500 kgs < GVWR ≤ 8,850 kgs)
- (62) Single unit straight truck (8,850 kgs < GVWR ≤ 12,000 kgs)
- (63) Single unit straight truck (> 12,000 kgs GVWR)
- (64) Single unit straight truck, GVWR unknown
- (65) Medium/heavy truck based motorhome
- (67) Truck-tractor with no cargo trailer
- (68) Truck-tractor pulling one trailer
- (69) Truck-tractor pulling two or more trailers
- (70) Truck-tractor (unknown if pulling trailer)
- (78) Unknown medium/heavy truck type
- (79) Unknown truck type (light/medium/heavy)

Motored Cycles (Does Not Include All-Terrain Vehicles/Cycles)

- (80) Motorcycle
- (81) Moped (motorized bicycle)
- (82) Three-wheel motorcycle or moped
- (88) Other motored cycle (minibike, motorscooter) (specify):

- (89) Unknown motored cycle type

Other Vehicles

- (90) ATV (All-Terrain Vehicle) and ATC (All-Terrain Cycle)
- (91) Snowmobile
- (92) Farm equipment other than trucks
- (93) Construction equipment other than trucks
- (97) Other vehicle type
- (99) Unknown body type

VEHICLE WEIGHT ITEMS

15. Vehicle Curb Weight 1.25 0Code weight to nearest
10 kilograms.

(045) Less than 450 kilograms

(610) 6,100 kilograms or more

(999) Unknown

2745 lbs X .4536 = 1.245 kgsSource: MVMA16. Vehicle Cargo Weight 9.99 0Code weight to nearest
10 kilograms.

(000) Less than 5 kilograms

(450) 4,500 kilograms or more

(999) Unknown

_____ lbs X .4536 = _____ kgs

RECONSTRUCTION DATA

18. Impact Speed

+ 999

_____ Nearest kmph

(NOTE: 000 means greater than .5 kmph)

(160) 159.5 kmph and above

(999) Unknown

19. Accuracy Range of Impact Speed Estimate 9

(0) No reconstruction

(1) Less than 2 kmph

(2) ≥ 2 kmph and ≤ 8 kmph(3) ≥ 9 kmph and ≤ 16 kmph(4) ≥ 17 kmph and ≤ 26 kmph

(9) Unknown

20. Data Source of Impact Speed 0

(0) No impact speed calculated

(1) Zone center calculation

(2) Police calculation

(3) Driver/witness/police estimates

PRECRASH DATA

21

Driver's Attention to Driving

(Prior to Recognition of Critical Event)

(1) Full attention to driving

(2) Distracted by other occupant

(3) Distracted by moving object in vehicle

(4) Distracted by outside person, object, or event

(5) Talking on cellular phone or CB radio

Specify: _____

(6) Sleeping or dozing while driving

(8) Other (specify): Drug/Alcohol involvement

(9) Unknown

22

Pre-Event Vehicle Movement

(Prior to Recognition of Critical Event)

(01) Going straight

(02) Slowing or stopping in traffic lane

(03) Starting in traffic lane

(04) Stopped in traffic lane

(05) Passing or overtaking another vehicle

(06) Disabled or parked in travel lane

(07) Leaving a parking position

(08) Entering a parking position

(09) Turning right

(10) Turning left

(11) Making a U-turn

(12) Backing up (other than for parking position)

(13) Negotiating a curve

(14) Changing lanes

(15) Merging

(16) Successful avoidance maneuver to a previous critical event

(97) Other (specify): _____

(98) No driver present

(99) Unknown

OTHER DATA

17. Vehicle Special Use (This Trip) 0

(0) No special use

(1) Taxi

(2) Vehicle used as school bus

(3) Vehicle used as other bus

(4) Military

(5) Police

(6) Ambulance

(7) Fire truck or car

(8) Other (specify): _____

(9) Unknown

STOP - VARIABLES 18 THROUGH 20

ARE COMPLETED BY THE ZONE CENTER

23. Critical Precrash Event

80*This Vehicle Loss of Control Due To:*

- (01) Blow out or flat tire
 (02) Stalled engine
 (03) Disabling vehicle failure (e.g., wheel fell off)
 (specify): _____
 (04) Non-disabling vehicle problem (e.g., hood flew up)
 (specify): _____
 (05) Poor road conditions (puddle, pot hole, ice, etc.)
 (specify): _____
 (06) Traveling too fast for conditions
 (08) Other cause of control loss (specify): _____

(09) Unknown cause of control loss

This Vehicle Traveling

- (10) Over the lane line on left side of travel lane
 (11) Over the lane line on right side of travel lane
 (12) Off the edge of the road on the left side
 (13) Off the edge of the road on the right side
 (14) End departure
 (15) Turning left at intersection
 (16) Turning right at intersection
 (17) Crossing over (passing through) intersection
 (19) Unknown travel direction

Other Motor Vehicle In Lane

- (50) Stopped
 (51) Traveling in same direction with lower speed
 (i.e., lower steady speed or decelerating)
 (52) Traveling in same direction with higher speed
 (53) Traveling in opposite direction
 (54) In crossover
 (55) Backing
 (59) Unknown travel direction of other motor vehicle
 in lane

Other Motor Vehicle Encroaching Into Lane

- (60) From adjacent lane (same direction)—over left
 lane line
 (61) From adjacent lane (same direction)—over right
 lane line
 (62) From opposite direction—over left lane line
 (63) From opposite direction—over right lane line
 (64) From parking lane
 (65) From crossing street, turning into same direction
 (66) From crossing street, across path
 (67) From crossing street, turning into opposite
 direction
 (68) From crossing street, intended path not known
 (70) From driveway, turning into same direction
 (71) From driveway, across path
 (72) From driveway, turning into opposite direction
 (73) From driveway, intended path not known
 (74) From entrance to limited access highway
 (78) Encroachment by other vehicle—details
 unknown

Pedestrian or Pedalcyclist, or Other Nonmotorist

- (80) Pedestrian in roadway
 (81) Pedestrian approaching roadway
 (82) Pedestrian—unknown location

(83) Pedalcyclist or other nonmotorist in roadway
(specify): _____(84) Pedalcyclist or other nonmotorist approaching
roadway (specify): _____(85) Pedalcyclist or other nonmotorist—unknown
location (specify): _____*Object or Animal*

- (87) Animal in roadway
 (88) Animal approaching roadway
 (89) Animal—unknown location
 (90) Object in roadway
 (91) Object approaching roadway
 (92) Object—unknown location
 (98) Other critical precrash event (specify): _____

(99) Unknown

24. Attempted Avoidance Maneuver

01
99

- (00) No driver present
 (01) No avoidance actions
 (02) Braking (no lockup)
 (03) Braking (lockup)
 (04) Braking (lockup unknown)
 (05) Releasing brakes
 (06) Steering left
 (07) Steering right
 (08) Braking and steering left
 (09) Braking and steering right
 (10) Accelerating
 (11) Accelerating and steering left
 (12) Accelerating and steering right
 (98) Other action (specify): _____
 (99) Unknown

25. Precrash Stability After Avoidance Maneuver

X
9

- (0) No driver present
 (1) No avoidance maneuver
 (2) Tracking
 (3) Skidding longitudinally—rotation less than 30
 degrees
 (4) Skidding laterally—clockwise rotation
 (5) Skidding laterally—counterclockwise rotation
 (8) Other vehicle loss-of-control (specify): _____
 (9) Precrash stability unknown

26. Precrash Directional Consequences of
Avoidance Maneuver (Corrective Action)X
9

- (0) No driver present
 (1) No avoidance maneuver
 (2) Vehicle stayed in travel lane where avoidance
 maneuver was initiated
 (3) Vehicle stayed on roadway but left travel lane
 where avoidance maneuver was initiated
 (4) Vehicle stayed on roadway, not known if left
 travel lane where avoidance maneuver was
 initiated
 (5) Vehicle departed roadway
 (6) Avoidance maneuver initiated off roadway
 (9) Directional consequences unknown

ENVIRONMENTAL DATA

27. Relation to Junction 2
- (0) Non-junction
(1) Interchange area

Non-Interchange

- (2) Intersection
(3) Intersection-related
(4) Drive, alley access related
(5) Other non-interchange (specify):

(6) Unknown type of non-interchange
(9) Unknown if interchange
28. Trafficway Flow 1
- (1) Not physically divided (two way traffic)
(2) Divided trafficway - median strip without positive barrier
(3) Divided trafficway - median strip with positive barrier
(4) One way trafficway
(9) Unknown

29. Number of Travel Lanes 4

- (1) One
(2) Two
(3) Three
(4) Four
(5) Five
(6) Six
(7) Seven or more
(9) Unknown

30. Roadway Alignment 1

- (1) Straight
(2) Curve right
(3) Curve left
(9) Unknown

31. Roadway Profile 1

- (1) Level
(2) Uphill Grade (> 2%)
(3) Downhill Grade (> 2%)
(4) Hillcrest
(5) Sag
(9) Unknown

32. Roadway Surface Type 2

- (1) Concrete
(2) Bituminous (asphalt)
(3) Brick or Block
(4) Slag, gravel or stone
(5) Dirt
(8) Other (specify):

(9) Unknown

33. Roadway Surface Condition 1

- (1) Dry
(2) Wet
(3) Snow and slush
(4) Ice
(5) Sand, dirt or oil
(8) Other (specify):
(9) Unknown

34. Traffic Control Device 0

- (0) No traffic control(s)
(1) Trafficway traffic control signal (not RR crossing)

Regulatory or School Zone Sign (Not RR Crossing)

- (2) Stop sign
(3) Yield sign
(4) School zone sign
(5) Other sign (specify):

(6) Unknown sign
(7) Warning sign (not RR crossing)
(8) Miscellaneous/other controls including RR controls (specify):

(9) Unknown

35. Traffic Control Device Functioning 0

- (0) No traffic control
(1) Not Functioning
(2) Functioning
(9) Unknown

36. Light Conditions 1

- (1) Daylight
(2) Dark
(3) Dark, but lighted
(4) Dawn
(5) Dusk
(9) Unknown

37. Atmospheric Conditions 1

- (1) No adverse atmospheric related driving conditions
(2) Rain
(3) Sleet
(4) Snow
(5) Fog
(6) Rain and fog
(7) Sleet and fog
(8) Other (e.g., smog, smoke, blowing sand or dust, etc.) (specify):
(9) Unknown



PEDESTRIAN EXTERIOR VEHICLE FORM

NATIONAL ACCIDENT SAMPLING SYSTEM
PEDESTRIAN CRASH DATA STUDY

1. Primary Sampling Unit Number

40

3. Vehicle Number

0 1

2. Case Number - Stratum

6 37 P
CD

VEHICLE IDENTIFICATION

VIN 1G1LD55M0T4 ~~XXXXXXXXXX~~

Model Year 96

Vehicle Make (specify): CHEVROLET

Vehicle Model (specify): CORSICA

4DR

PEDESTRIAN FRONT CONTACT WORK SHEET

PEV06 Hood Material

STEEL

PEV08 Hood Length

114 cm

PEV09 Hood Width-Forward Opening

134 cm

PEV10 Hood Width-Midway

140 cm

PEV11 Hood Width-Rear Opening

147 cm

PEV14 Front Bumper Cover Material

PLASTIC

PEV15 Front Bumper Reinforcement Material

STEEL

VERTICAL MEASUREMENTS

PEV16 Front Bumper-Bottom Height

36 cm

PEV17 Front Bumper-Top Height

51 cm

PEV18 Forward Hood Opening

64 cm

PEV19 Front Bumper Lead

9 cm

WRAP DISTANCES

PEV20 Ground to Forward Hood Opening

69 cm

PEV21 Ground to Front/Top Transition Point

75 cm

PEV22 Ground to Rear Hood Opening

182 cm

PEV23 Ground to Base of Windshield

191 cm

PEV24 Ground to Top of Windshield

270 cm

PEV25 Ground to Head Contact

224 cm

Major 152

VEHICLE DAMAGE SKETCH

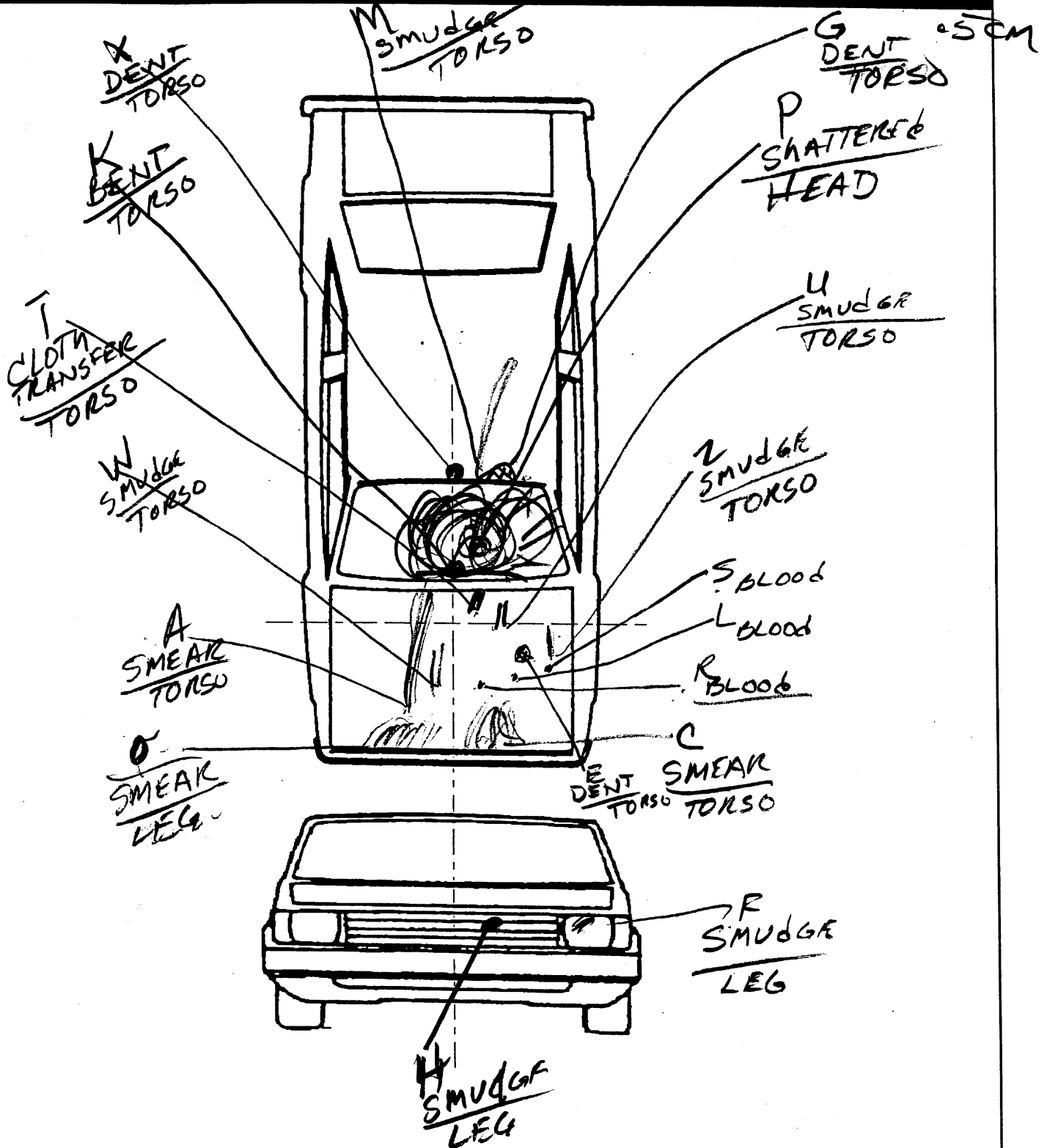

NOTES: Sketch all pedestrian contacts, include the size and depth in centimeters. Locate the pedestrian contacts from the intercept point of the centerline (lateral) and the front axles (longitudinal) in centimeters. Annotate observations which might be useful in reconstructing the accident (e.g., grass in tire bead, direction of striations, scuff on sidewalls, etc.).

Location of the origin (intercept point of the centerline and the front axles) from the ground: 152cm

PEDESTRIAN SIDE CONTACT WORK SHEET

PEV06 Hood Material	_____	
PEV08 Hood Length	_____	cm
PEV09 Hood Width-Forward Opening	_____	cm
PEV10 Hood Width-Midway	_____	cm
PEV11 Hood Width-Rear Opening	_____	cm

VERTICAL MEASUREMENTS

PEV26 Ground Clearance	_____	cm
PEV27 Side Bumper-Bottom Height	_____	cm
PEV28 Side Bumper-Top Height	_____	cm
PEV29 Centerline of Wheel	_____	cm
PEV30 Top of Tire	_____	cm
PEV31 Top of Wheel Well Opening	_____	cm
PEV32 Bottom of A-Pillar at Windshield	_____	cm
PEV33 Top of A-Pillar at Windshield	_____	cm
PEV34 Top of Side View Mirror	_____	cm

LATERAL MEASUREMENTS

PEV35 C _L to A-Pillar at Bottom of Windshield	_____	cm
PEV36 C _L to A-Pillar at Top of Windshield	_____	cm
PEV37 C _L to Maximum Side View Mirror Protrusion	_____	cm

WRAP DISTANCES

PEV38 Ground to Side/Top Transition	_____	cm
PEV39 Ground to Hood Edge	_____	cm
PEV40 Ground to Centerline of Hood (ORIGIN)	_____	cm
PEV41 Ground to Head Contact	_____	cm

VEHICLE DAMAGE SKETCH

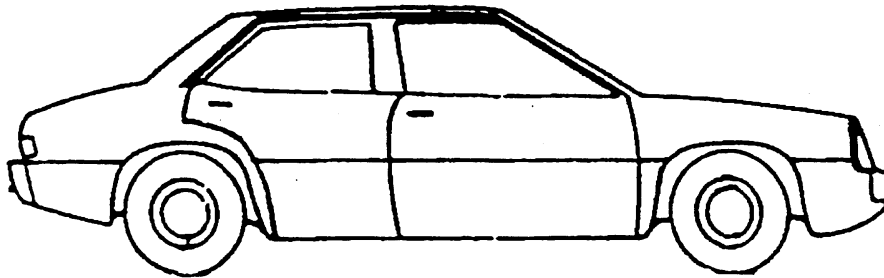
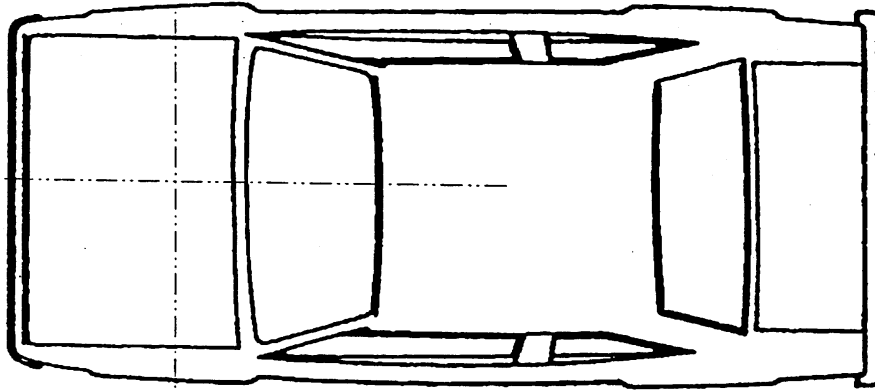
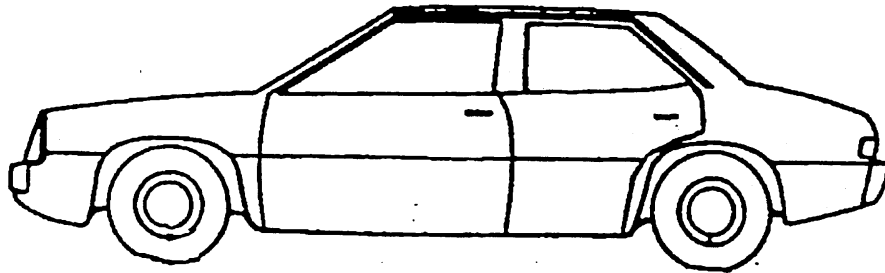

NOTES: Sketch all pedestrian contacts, include the size and depth in centimeters. Locate the pedestrian contacts from the intercept point of the centerline (lateral) and the front axes (longitudinal) in centimeters. Annotate observations which might be useful in reconstructing the accident (e.g., grass in tire bead, direction of striations, scuff on sidewalls, etc.).

Location of the origin (intercept point of the centerline and the front axes) from the ground: _____ cm

ORIGINAL SPECIFICATIONS

Wheelbase	<u>103.4</u> inches	x 2.54 =	<u>263</u> cm
Overall Length	<u>183.5</u> inches	x 2.54 =	<u>466</u> cm
Maximum Width	<u>68.0</u> inches	x 2.54 =	<u>173</u> cm
Curb Weight	<u>2,745</u> pounds	x .4536 =	<u>1,245</u> kg
Average Track	<u>56.2</u> inches	x 2.54 =	<u>143</u> cm
Front Overhang	___ . ___ inches	x 2.54 =	___ . ___ cm
Rear Overhang	___ . ___ inches	x 2.54 =	___ . ___ cm
Undeformed End Width	___ . ___ inches	x 2.54 =	___ . ___ cm
Engine Size: cyl./displ.	___ . ___ cc	x .001 =	<u>3.1</u> L
	___ . ___ CID	x .0164 =	___ . ___ L

MVMA

INJURY SOURCE

FRONT

- 700 Front bumper
- 701 Front lower valance/spoiler
- 702 Front grille
- 703 Hood edge and/or trim
- 704 Hood ornament (fixed)
- 705 Hood ornament (spring loaded)
- 706 Headlight
- 707 Retractable headlight door (Open/Closed)
- 708 Turn signal/parking lights
- 718 Other front or add on object (specify): _____
- 719 Unknown front object

Left Side Components

- 720 Front fender side surface
- 721 Front antenna
- 722 A1 pillar
- 723 A2 pillar
- 724 B pillar
- 725 C pillar
- 726 D pillar
- 728 Other pillar (specify): _____
- 729 Left side roof rail
- 730 Left side door surface
- 731 Left side door handle
- 732 Left side mirror fixed housing
- 733 Left side folding mirror
- 734 Left side glazing forward of B pillar
- 735 Left side glazing rearward of B pillar
- 736 Left side back fender or quarter panel
- 737 Rear antenna
- 738 Other left side object (specify): _____
- 739 Unknown left side component

Right Side Components

- 740 Front fender side surface
- 741 Front antenna
- 742 A1 pillar
- 743 A2 pillar

- 744 B pillar
- 745 C pillar
- 746 D pillar
- 748 Other pillar (specify): _____
- 749 Right side roof rail
- 750 Right side door surface
- 751 Right side door handle
- 752 Right side mirror fixed housing
- 753 Right side folding mirror
- 754 Right side glazing forward of B pillar
- 755 Right side glazing rearward of B pillar
- 756 Rear antenna
- 757 Rear fender or quarter panel
- 758 Other right side object (specify): _____
- 759 Unknown right side component

Back Components

- 760 Rear (back) bumper
- 761 Tailgate
- 762 Hatchback, vertical surface
- 768 Other back component (specify): _____
- 769 Unknown back component

Top Components

- 770 Hood surface
- 771 Hood surface reinforced by under hood component
- 772 Front fender top surface
- 773 Cowl area
- 774 Wiper blade & mountings
- 775 Windshield glazing
- 776 Front header
- 777 Roof surface
- 778 Backlight glazing
- 779 Rear header
- 780 Hatchback
- 781 Rear trunk lid
- 788 Other top component (specify): _____
- 789 Unknown top component

Wheels / tires

- 790 Left front wheel / tire
- 791 Right front wheel / tire
- 792 Left rear wheel / tire
- 793 Right rear wheel / tire
- 798 Other wheel / tire (specify): _____
- 799 Unknown wheel / tire

Undercarriage components

- 800 Front cross member
- 801 Steering assembly/Front suspension
- 802 Oil pan
- 803 Exhaust system pipe
- 804 Transmission
- 805 Drive shaft
- 806 Catalytic converter
- 807 Muffler
- 808 Floor pan
- 809 Fuel tank
- 810 Rear suspension
- 818 Other undercarriage component (specify): _____
- 819 Unknown undercarriage component

Accessories

- 820 Air scoop, deflector
- 821 Cellular or CB radio antenna
- 822 Emergency lights or bar
- 823 Fog lights
- 824 Luggage, ski, or bike rack
- 825 Cargo (specify): _____
- 826 Spare tire
- 827 Spotlight
- 828 Other accessory (specify): _____

Other Object or Vehicle in Environment

- 947 Ground
- 948 Other object (specify): _____
- 949 Unknown object in environment
- 959 Unknown object on contacting vehicle
- 997 Noncontact injury source
- 999 Unknown injury source

VEHICLE DIMENSIONS

4. Original Wheelbase 263
 _____ Code to the
 nearest centimeter
 (999) Unknown

1034 inches X 2.54 = 263 centimeters

5. Original Average Track Width 143
 _____ Code to the
 nearest centimeter
 (185) 185 centimeters or more
 (999) Unknown

56.2 inches X 2.54 = 143 centimeters

6. Hood Material 3
 (1) Plastic
 (2) Fiberglass
 (3) Steel
 (4) Aluminum
 (5) Stainless Steel
 (8) Other (specify): _____
 (9) Unknown

7. Hood Original 1
 Equipment Manufacturer (OEM)
 (1) OEM factory installed hood
 (2) OEM replacement
 (3) Non-OEM replacement
 (9) Unknown

8. Hood Length 114
 _____ Code to the
 nearest centimeter
 (180) 180 centimeters or more
 (999) Unknown

44.9 inches X 2.54 = 114 centimeter

9. Hood Width Forward Opening 134
 _____ Code to the
 nearest centimeter
 (210) 210 centimeters or more
 (999) Unknown

52.8 inches X 2.54 = 134 centimeters

10. Hood Width Midway 140
 _____ Code to the
 nearest centimeter
 (210) 210 centimeters or more
 (999) Unknown

55.1 inches X 2.54 = 140 centimeters

11. Hood Width Rear Opening 147
 _____ Code to the
 nearest centimeter
 (210) 210 centimeters or more
 (999) Unknown

57.9 inches X 2.54 = 147 centimeters

12. Hood/Fender Vertical/Lateral Crush From Pedestrian 1
 (0) Not damaged
 (1) Surface scratching only, no residual crush
 (2) Minor crush (1-3 centimeters)
 (3) Moderate crush (4-7 centimeters)
 (4) Severe crush (>7 centimeters)
 (8) Damage present, unknown if damage is from pedestrian impact
 (9) Unknown

13. Windshield Contact Damage 2
 From Pedestrian Contact
 (0) Not contacted by pedestrian
 (1) Contacted by pedestrian - not damaged
 (2) Contacted by pedestrian - damaged
 (3) Unknown if contacted by pedestrian - not damaged
 (4) Unknown if contacted by pedestrian - damaged
 (9) Unknown if contacted by pedestrian - unknown if damaged

FRONT CONTACT DAMAGE

Front Vertical Measurements

14. Front Bumper Cover Material 1
 (0) No front contact
 (1) Plastic
 (2) Fiberglass
 (3) Rubber
 (4) Other (specify): _____
 (9) Unknown

15. Front Bumper Reinforcement Material 1
 (0) No front contact
 (1) Steel
 (2) Aluminum
 (3) Stainless Steel
 (4) Other (specify): _____
 (9) Unknown

16. Front Bumper-Bottom Height 036
 _____ Code to the
 nearest centimeter
 (000) No front contact
 (150) 150 centimeters or more
 (999) Unknown

14.2 inches X 2.54 = 036 centimeters

17. Front Bumper-Top Height 051
 _____ Code to the
 nearest centimeter
 (000) No front contact
 (150) 150 centimeters or more
 (999) Unknown

20.1 inches X 2.54 = 51 centimeters

18. Forward Hood Opening 064
 _____ Code to the
 nearest centimeter
 (000) No front contact
 (200) 200 centimeters or more
 (999) Unknown

25.2 inches X 2.54 = 64 centimeters

19. Front Bumper Lead 09
 (00) No front contact
 _____ Code to the
 nearest centimeter
 (30) 30 centimeters or more
 (99) Unknown

3.5 inches X 2.54 = 9 centimeters

23. Ground to Base of Windshield 191
 _____ Code to the
 nearest centimeter
 (000) No front contact
 (400) 400 centimeters or more
 (999) Unknown

75.2 inches X 2.54 = 191 centimeters

24. Ground to Top of Windshield 270
 _____ Code to the
 nearest centimeter
 (000) No front contact
 (500) 500 centimeters or more
 (999) Unknown

106.3 inches X 2.54 = 270 centimeters

25. Ground To Head Contact 224
 _____ Code to the
 nearest centimeter
 (000) No front contact
 (400) 400 centimeters or more
 (998) No head contact
 (999) Unknown

88.2 inches X 2.54 = 224 centimeters

Front Wrap Distance Measurements

20. Ground to Forward Hood Opening 069
 _____ Code to the
 nearest centimeter
 (000) No front contact
 (200) 200 centimeters or more
 (999) Unknown

27.2 inches X 2.54 = 69 centimeters

21. Ground to Front/Top Transition Point 075
 _____ Code to the
 nearest centimeter
 (000) No front contact
 (180) 180 centimeters or more
 (999) Unknown

29.5 inches X 2.54 = 75 centimeters

22. Ground to Rear Hood Opening 182
 _____ Code to the
 nearest centimeter
 (000) No front contact
 (400) 400 centimeters or more
 (999) Unknown

71.7 inches X 2.54 = 182 centimeters

SIDE CONTACT DAMAGE

Side Vertical Measurements

26. Ground Clearance 000
 _____ Code to the
 nearest centimeter
 (000) No side contact
 (150) 150 centimeters or more
 (999) Unknown

_____ inches X 2.54 = _____ centimeters

27. Side Bumper-Bottom Height 000
 _____ Code to the
 nearest centimeter
 (000) No side contact
 (150) 150 centimeters or more
 (999) Unknown

_____ inches X 2.54 = _____ centimeters

28. Side Bumper-Top Height 000
 _____ Code to the
 nearest centimeter
 (000) No side contact
 (150) 150 centimeters or more
 (999) Unknown

_____ inches X 2.54 = _____ centimeters

29. Centerline of Wheel
 _____ Code to the nearest centimeter
 (000) No side contact
 (150) 150 centimeters or more
 (999) Unknown

0 0 0

_____ inches X 2.54 = _____ centimeters

30. Top of Tire
 _____ Code to the nearest centimeter
 (000) No side contact
 (200) 200 centimeters or more
 (999) Unknown

0 0 0

_____ inches X 2.54 = _____ centimeters

31. Top of Wheel Well Opening
 _____ Code to the nearest centimeter
 (000) No side contact
 (250) 250 centimeters or more
 (999) Unknown

0 0 0

_____ inches X 2.54 = _____ centimeters

32. Bottom of A-Pillar at Windshield
 _____ Code to the nearest centimeter
 (000) No side contact
 (250) 250 centimeters or more
 (999) Unknown

0 0 0

_____ inches X 2.54 = _____ centimeters

33. Top of A-Pillar at Windshield
 _____ Code to the nearest centimeter
 (000) No side contact
 (300) 300 centimeters or more
 (999) Unknown

0 0 0

_____ inches X 2.54 = _____ centimeters

34. Top of Side View Mirror
 _____ Code to the nearest centimeter
 (000) No side contact
 (300) 300 centimeters or more
 (999) Unknown

0 0 0

_____ inches X 2.54 = _____ centimeters

Side Lateral Measurements

35. Centerline to A-Pillar at Bottom of Windshield
 _____ Code to the nearest centimeter
 (000) No side contact
 (250) 250 centimeters or more
 (999) Unknown

0 0 0

_____ inches X 2.54 = _____ centimeters

36. Centerline to A-Pillar at Top of Windshield
 _____ Code to the nearest centimeter
 (000) No side contact
 (250) 250 centimeters or more
 (999) Unknown

0 0 0

_____ inches X 2.54 = _____ centimeter

37. Centerline to Maximum Side View Mirror Protrusion
 _____ Code to the nearest centimeter
 (000) No side contact
 (300) 300 centimeters or more
 (999) Unknown

0 0 0

_____ inches X 2.54 = _____ centimeter

Side Wrap Distance Measurements

38. Ground to Side/Top Transition
 _____ Code to the nearest centimeter
 (000) No side contact
 (400) 400 centimeters or more
 (999) Unknown

0 0 0

_____ inches X 2.54 = _____ centimeters

39. Ground to Hood Edge
 _____ Code to the nearest centimeter
 (000) No side contact
 (500) 500 centimeters or more
 (999) Unknown

0 0 0

_____ inches X 2.54 = _____ centimeters

40. Ground to Centerline of Hood

000

Code to the nearest centimeter

(000) No side contact

(700) 700 centimeters or more

(999) Unknown

_____ inches X 2.54 = _____ centimeters

41. Ground to Head Contact

000

Code to the nearest centimeter

(000) No side contact

(800) 800 centimeters or more

(998) No head contact

(999) Unknown

_____ inches X 2.54 = _____ centimeters

1

PSU40
CASE 637P

1997 PEDESTRIAN ACCIDENT FORM

IDENTIFICATION

3. Number of General Vehicle Forms Submitted 01
4. Date of Accident (Month, Day, Year) [REDACTED]/97
5. Time of Accident (military time) 1355

SPECIAL STUDIES - INDICATORS

6. SS15 0 7. SS16 1 8. SS17 0 9. SS18 0 10. SS19 0

NUMBER OF EVENTS

11. Number of Recorded Events in This Accident 01
01

PSU40
CASE 637P

1997 PEDESTRIAN ACCIDENT FORM

PEDESTRIAN ACCIDENT EVENTS

Accident Sequence Number	Vehicle Number	Class of Vehicle	General Area of Damage	Veh. Num. or Obj. Cont.	Class of Vehicle	General Area of Damage
12. 01	13. 01	14. 02	15. F	16. 72	17. 00	18. 0

01

PEDESTRIAN'S CHARACTERISTICS

4. Pedestrian's Age	28
5. Pedestrian's Sex	1
6. Pedestrian's Overall Height	999
7. Pedestrian's Height - Ground to Knee	99
8. Pedestrian's Height - Ground to Hip	999
9. Pedestrian's Height - Ground to Shoulder	999
10. Pedestrian's Weight	999

PEDESTRIAN'S PRE-AVOIDANCE ACTIONS

11. Pedestrian's Attitude	1
12. Pedestrian's Motion	9
13. Pedestrian's Actions Relative to Vehicle	99
14. Pedestrian's Body (Chest) Orientation Relative to Striking Vehicle Prior to Avoidance Actions	9

PEDESTRIAN'S AVOIDANCE ACTIONS

15. Pedestrian's First Avoidance Actions	99
--	----

PEDESTRIAN'S ORIENTATION AT IMPACT

16. Pedestrian's Head Orientation at Initial Impact	9
17. Pedestrian's Body (Chest) Orientation at Initial Impact	9
18. Pedestrian's Arm Orientation at Initial Impact	99
19. Pedestrian's Leg Orientation at Initial Impact	99
20. Vehicle/Pedestrian's Interaction	02

OFFICIAL RECORDS

21. Police Reported Alcohol Presence For Pedestrian	7
22. Alcohol Test Result For Pedestrian	96
23. Police Reported Other Drug Presence For Pedestrian	0
24. Other Drug Specimen Test Result For Pedestrian	0

INJURY CONSEQUENCES

25. Injury Severity (Police Rating)	3
26. Treatment - Mortality	3
27. Type of Medical Facility (for Initial Treatment)	1
28. Hospital Stay	99
29. Working Days Lost	99

(COMPLETED BY THE ZONE CENTER)

30. Glasgow Coma Scale Score	12
31. Was the Pedestrian Given Blood?	9
32. Arterial Blood Gases	01
33. Time to Death	00
34. 1st Medically Reported Cause of Death	00
35. 2nd Medically Reported Cause of Death	00
36. 3rd Medically Reported Cause of Death	00
37. Number of Recorded Injuries for This Pedestrian	09

PSU40

1997 PEDESTRIAN INJURY FORM

CASE 637P

VEHICLE 01 PEDESTRIAN 01

PEDESTRIAN INJURY DATA

	Source of Inj. Data	Body Reg.	Type of Anat. Struc.	Spec. Anat. Struc.	Lev. of Inj.	AIS Sev.	Asp.	Inj. Source	Inj. Conf. Level	Dir./ Indir. Inj.	Str. Pro.	Type of Dmg.	Dmg. Dep.
01.	2	1	4	06	22	3	3	775	1	1	2	5	5
02.	2	4	5	02	22	3	1	770	1	1	2	3	3
03.	2	8	5	16	06	2	2	702	1	1	2	2	2
04.	2	8	5	34	22	3	2	706	1	1	2	2	2
05.	3	1	9	06	02	1	6	775	1	1	2	5	5
06.	3	1	6	06	99	2	0	775	1	1	2	5	5
07.	3	1	9	02	02	1	9	775	1	1	2	5	5
08.	2	1	4	06	40	4	1	775	1	1	2	5	5
09.	3	9	9	04	00	1	0	775	1	1	2	5	5

01

PSU40
CASE 637P
VEHICLE 01

1997 PEDESTRIAN GENERAL VEHICLE FORM

VEHICLE IDENTIFICATION

4. Vehicle Model Year	96
5. Vehicle Make	20
6. Vehicle Model	019
7. Body Type	04
8. Vehicle Identification Number	1G1LD55MOTV [REDACTED]

OFFICIAL RECORDS

9. Police Reported Travel Speed	999
10. Speed Limit	048
11. Police Reported Alcohol Presence For Driver	1
12. Alcohol Test Result For Driver	99
13. Police Reported Other Drug Presence	1
14. Other Drug Specimen Test Result for Driver	9

VEHICLE WEIGHT ITEMS

15. Vehicle Curb Weight	1,250
16. Vehicle Cargo Weight	9,990

OTHER DATA

17. Vehicle Special Use (This Trip)	0
-------------------------------------	---

RECONSTRUCTION DATA (COMPLETED BY THE ZONE CENTER)

18. Impact Speed	+999
19. Accuracy Range of Impact Speed Estimate	9
20. Data Source of Impact Speed	0

PRECRASH DATA

21. Driver's Attention to Driving	8
22. Pre-Event Vehicle Movement	01

PRECRASH DATA (continued)

23. Critical Precrash Event	80
24. Attempted Avoidance Maneuver	99
25. Precrash Stability After Avoidance Maneuver	9
26. Precrash Directional Consequences of Avoidance Manuver (Corrective Action)	9

ENVIRONMENTAL DATA

27. Relation to Junction	2
28. Trafficway Flow	1
29. Number of Travel Lanes	4
30. Roadway Alignment	1
31. Roadway Profile	1
32. Roadway Surface Type	2
33. Roadway Surface Condition	1
34. Traffic Control Device	0
35. Traffic Control Device Functioning	0
36. Light Conditions	1
37. Atmospheric Conditions	1

01

PSU40
CASE 637P
VEHICLE 01

1997 PEDESTRIAN EXTERIOR VEHICLE FORM

VEHICLE DIMENSIONS

4. Original Wheelbase	263
5. Original Average Track Width	143
6. Hood Material	3
7. Hood Original Equip. Manufacturer	1
8. Hood Length	114
9. Hood Width Forward Opening	134
10. Hood Width Midway	140
11. Hood Width Rear Opening	147
12. Hood/Fender Vertical/Lateral Crush From Pedestrian	1
13. Windshield Contact Damage From Pedestrian Contact	2

FRONT CONTACT DAMAGE

FRONT VERTICAL MEASUREMENTS

14. Front Bumper Cover Material	1	15. Front Bumper Reinforcement Mat.	1
16. Front Bumper-Bottom Height	036	17. Front Bumper-Top Height	051
18. Forward Hood Opening	064	19. Front Bumper Lead	09

FRONT WRAP DISTANCE MEASUREMENTS

20. Ground to Fwd. Hood Opening	069	21. Ground to Front/Top Transition Pt	075
22. Ground to Rear Hood Opening	182	23. Ground to Base of Windshield	191
24. Ground to Top of Windshield	270	25. Ground to Head Contact	224

SIDE CONTACT DAMAGE

SIDE VERTICAL MEASUREMENTS

26. Ground Clearance	000
27. Side Bumper-Bottom Height	000
28. Side Bumper-Top Height	000
29. Centerline of Wheel	000
30. Top of Tire	000
31. Top of Wheel Well Opening	000
32. Bottom of A-Pillar at Windshield	000
33. Top of A-Pillar at Windshield	000
34. Top of Side View Mirror	000

SIDE CONTACT DAMAGE (continued)

SIDE LATERAL MEASUREMENTS

35. Centerline to A-Pillar at Bottom of Windshield	000
36. Centerline to A-Pillar at Top of Windshield	000
37. Centerline to Maximum Side View Mirror Protrusion	000

SIDE WRAP DISTANCE MEASUREMENTS

38. Ground to Side/Top Transition	000
39. Ground to Hood Edge	000
40. Ground to Centerline of Hood (Origin)	000
41. Ground to Head Contact	000

01

PSU40

1997 PEDESTRIAN EXTERIOR VEHICLE FORM

CASE 637P

VEHICLE 01

```
40637P0000001[REDACTED]9710.0000000000000113550100001[REDACTED]98 [REDACTED]980115980000000000
000000000000000 01
40637P00010012[REDACTED]9710.010000000000102F72000
40637P00010021 10.0 000000000281999999999999991999999999990279600331999912
90100000000009
40637P00010131 10.0 00000000021406223377511255
40637P00010231 10.0 00000000024502223177011233
40637P00010331 10.0 00000000028516062270211222
40637P00010431 10.0 00000000028534223270611222
40637P00010531 10.0 00000000031906021677511255
40637P00010631 10.0 00000000031606992077511255
40637P00010731 10.0 00000000031902021977511255
40637P00010831 10.0 00000000021406404177511255
40637P00010931 10.0 00000000039904001077511255
40637P01000041 10.0 000000000962001904161LD55M0 [REDACTED]2499904819919125999099
99080180999921411210011
40637P01000051 10.0 0000000002631433111413414014712110360510640906907518219
1270224000000000000000000000000000000000000000000000000000000000000000000000000000000
40637P99999999000000000000000000000000000000000000000000000000000000000000000000000000000
000000000000000
```

PSU40
CASE 637P
CURRENT VERSION: 10.0

ERROR SUMMARY SCREEN
PEDESTRIAN STUDY

FORM NAME	NUMBER OF DOLLAR SIGNS	NUMBER OF LEVEL 1 ERRORS	NUMBER OF LEVEL 2 ERRORS	VERSION NUMBER CONSISTENT
Pedestrian Accident	0	0	0	Y
Pedestrian Assessment	0	0	0	Y
Pedestrian Injury	0	0	0	Y
Pedestrian General Vehicle	0	0	0	Y
Pedestrian Exterior Vehicle	0	0	0	Y
Total Inter Errors		0	0	
Total Case Errors	0	0	0	